

## EEPROM2 click

### 2. Soldering the headers

Before using your click board™, make sure to solder 1x8 male headers to both left and right side of the board. Two 1x8 male headers are included with the board in the package.

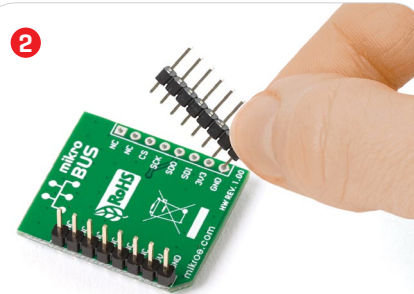
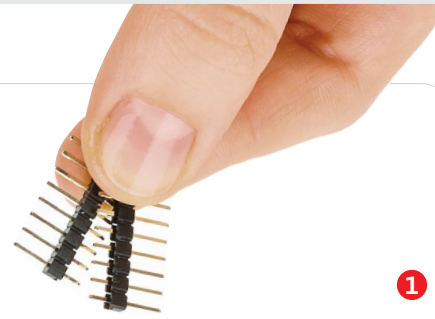

Turn the board upside down so that the bottom side is facing you upwards. Place shorter pins of the header into the appropriate soldering pads.

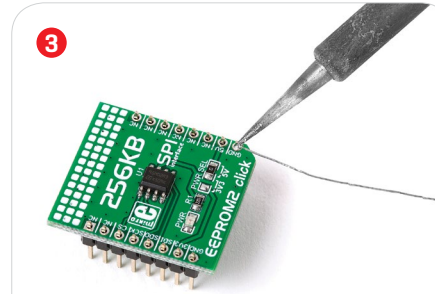

Turn the board upward again. Make sure to align the headers so that they are perpendicular to the board, then solder the pins carefully.

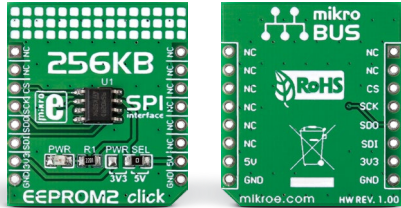

### 1. Introduction

EEPROM2 click carries ST's **M95M02** DIP-8 socket EEPROM chip with 256 KB of memory. The board communicates with the target MCU through the mikroBUS™ SPI interface [CS, SCK, MISO and MOSI pins] with speeds up to 5 MHz. The chip allows for an entire page of data [256 bytes] to be written in a single Write cycle. The board is designed to use either a 3.3V or a 5V power supply. A onboard LED will indicate the presence of a power supply.

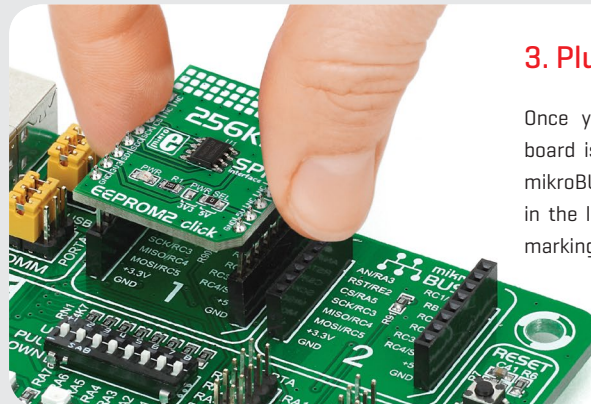

### 3. Plugging the board in

Once you have soldered the headers your board is ready to be placed into the desired mikroBUS™ socket. Make sure to align the cut in the lower-right part of the board with the markings on the silkscreen at the mikroBUS™ socket. If all the pins are aligned correctly, push the board all the way into the socket.

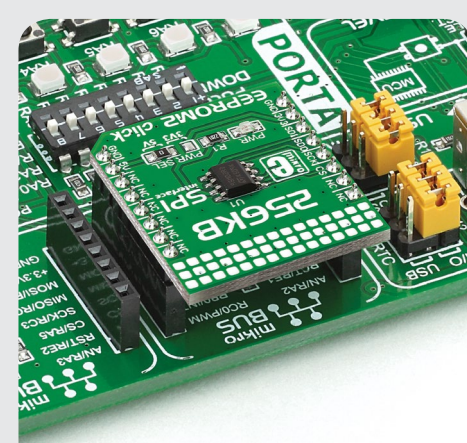

### 4. Essential features

The M95M02 device has byte and page write speeds equal or less than 10 ms. The chip is specified for more than 4 million write cycles, with more than 200 years of data retention. The clock frequency is 5 MHz. The memory is organized as 262144 x 8 bits. EEPROM2 click is suitable for storing initialization and configuration data in your designs.

**click**  
BOARD™  
[www.mikroe.com](http://www.mikroe.com)



EEPROM2 click manual  
ver 1.00



010000080795

## 5. Schematic

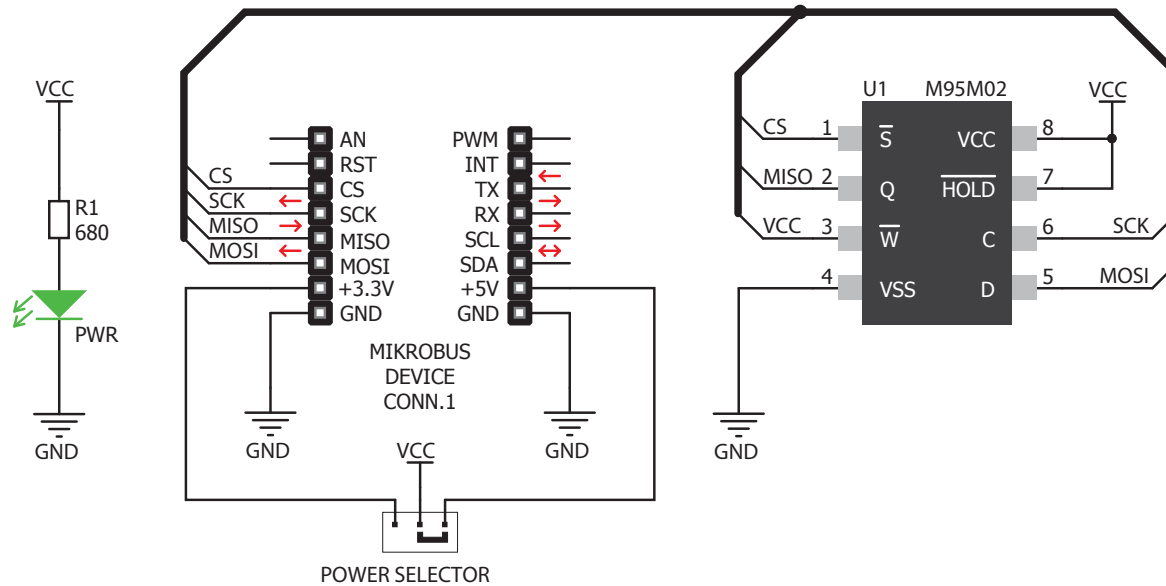

## 6. Dimensions

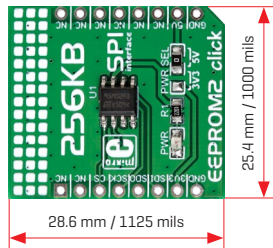

	mm	mils
LENGTH	28.6	1125
WIDTH	25.4	1000
HEIGHT*	3.2	126

\* without headers

## 7. SMD jumpers



The board features a PWR SEL jumper which is used to determine whether 5V or 3.3V power supply is used.

## 8. Code examples

Once you have done all the necessary preparations, it's time to get your click board™ up and running. We have provided examples for mikroC™, mikroBasic™ and mikroPascal™ compilers on our **Libstock** website. Just download them and you are ready to start.



## 9. Support

MikroElektronika offers **free tech support** [[www.mikroe.com/support](http://www.mikroe.com/support)] until the end of the product's lifetime, so if something goes wrong, we're ready and willing to help!



## 10. Disclaimer

MikroElektronika assumes no responsibility or liability for any errors or inaccuracies that may appear in the present document. Specification and information contained in the present schematic are subject to change at any time without notice.

Copyright © 2015 MikroElektronika.  
All rights reserved.

# Mouser Electronics

Authorized Distributor

Click to View Pricing, Inventory, Delivery & Lifecycle Information:

[MikroElektronika:](#)

[MIKROE-1909](#)