

# ULTRA MINIATURE CERAMIC PACKAGE HIGH STABILITY SMD CRYSTAL



3.2 x 2.5 x 0.6mm

## ABM8X

RoHS/RoHS II Compliant

**Moisture Sensitivity Level (MSL) – This product is Hermetically Sealed and not Moisture Sensitive - MSL = N/A: Not Applicable**

### FEATURES:

- -40°C to +125°C wide operating temperature range
- ±40 ppm Max. All Inclusive frequency stability over 10-year product life
- Fundamental Mode, low ESR Quartz design
- Ultra miniature, Seam-Sealed, RoHS compliant reflow-able package

### APPLICATIONS:

- Zigbee based designs for indoor / outdoor applications
- Wireless Sensor Networks
- Industrial Control
- Home and Building Automation
- Consumer Electronics
- PC Peripherals

### STANDARD SPECIFICATIONS

Parameters	Minimum	Typical	Maximum	Units	Notes
Center Frequency		24.000 32.000		MHz	
Operation Mode	Fundamental				
Operating Temperature	-40		+125	°C	
Storage Temperature	-55		+155	°C	
Overall Frequency Stability (All inclusive)	-40		+40	ppm	
Frequency Tolerance	-10		+10	ppm	
Frequency Stability over the Operating Temperature Range ( ref. to +25°C)	-25		+25	ppm	
Aging	-5		+5	ppm	@25±3°C 10 years
Equivalent series resistance (R1)			60	Ω	
Shunt capacitance (C0)			2.5	pF	
Motional capacitance (C1)		2.0		fF	
Load capacitance (CL)		10		pF	
Drive Level		50	100	μW	
Insulation Resistance	500			MΩ	@100Vdc±15V

### Options and Part Identification (left blank if standard)

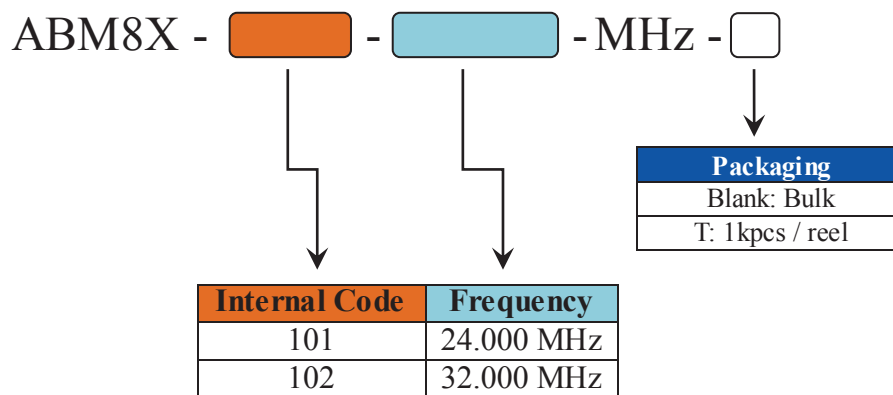

**Example Part #:** ABM8X-101-24.000MHz-T

# ULTRA MINIATURE CERAMIC PACKAGE HIGH STABILITY SMD CRYSTAL



3.2 x 2.5 x 0.6mm

**ABM8X**



RoHS/RoHS II Compliant

## OUTLINE DIMENSIONS:

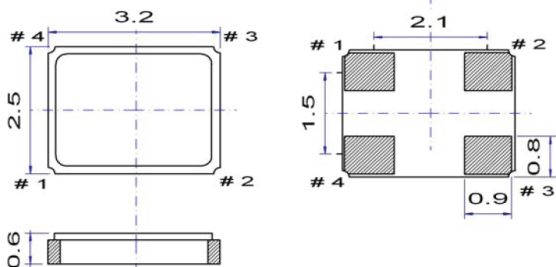

Pin function

- # 1 crystal connection
- # 2 GND
- # 3 crystal connection
- # 4 GND

Top view

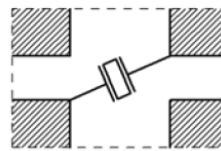

Pad #2 & #4 connected with the metal cap

Do not design any conductive path between the pattern

Example for solder pattern

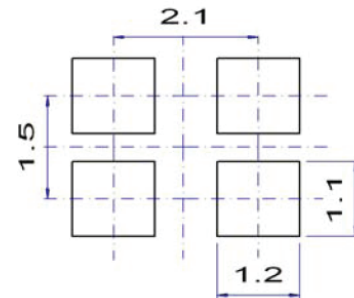

Dimensions: mm

## REFLOW PROFILE:

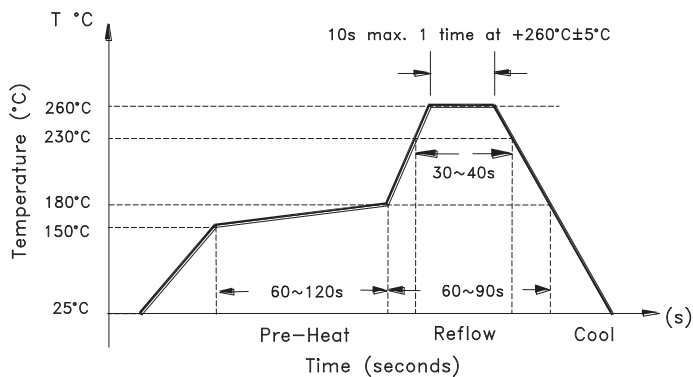

## TAPE & REEL:

1000pcs/reel

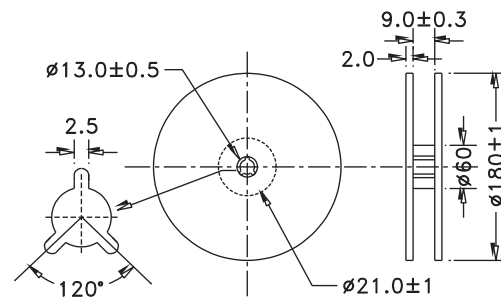
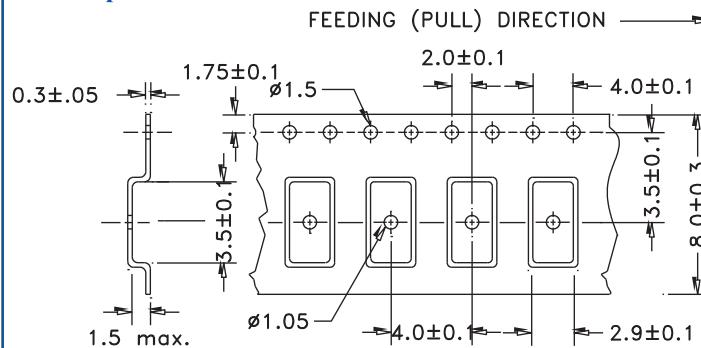

Dimensions: mm



Need a test socket for the ABM8X Series? To view compatible **PRECISION TEST & BURN-IN SOCKETS** for these parts, [click here](#). P/N **AXS-3225-04-01**

**ATTENTION:** Abracon Corporation's products are COTS – Commercial-Off-The-Shelf products; suitable for Commercial, Industrial and, where designated, Automotive Applications. Abracon's products are not specifically designed for Military, Aviation, Aerospace, Life-dependant Medical applications or any application requiring high reliability where component failure could result in loss of life and/or property. For applications requiring high reliability and/or presenting an extreme operating environment, written consent and authorization from Abracon Corporation is required. Please contact Abracon Corporation for more information.

ABRACON IS  
ISO9001:2008  
CERTIFIED



Visit [www.abracon.com](http://www.abracon.com) for Terms & Conditions of Sale **Revised: 04.10.12**

30332 Esperanza, Rancho Santa Margarita, California 92688

tel 949-546-8000 | fax 949-546-8001 | [www.abracon.com](http://www.abracon.com)

# Mouser Electronics

Authorized Distributor

Click to View Pricing, Inventory, Delivery & Lifecycle Information:

[ABRACON:](#)

[ABM8X-101-24.000MHz-T](#) [ABM8X-102-32.000MHz-T](#) [ABM8-156-20.000MHZ-T](#)